

TOP VIEW

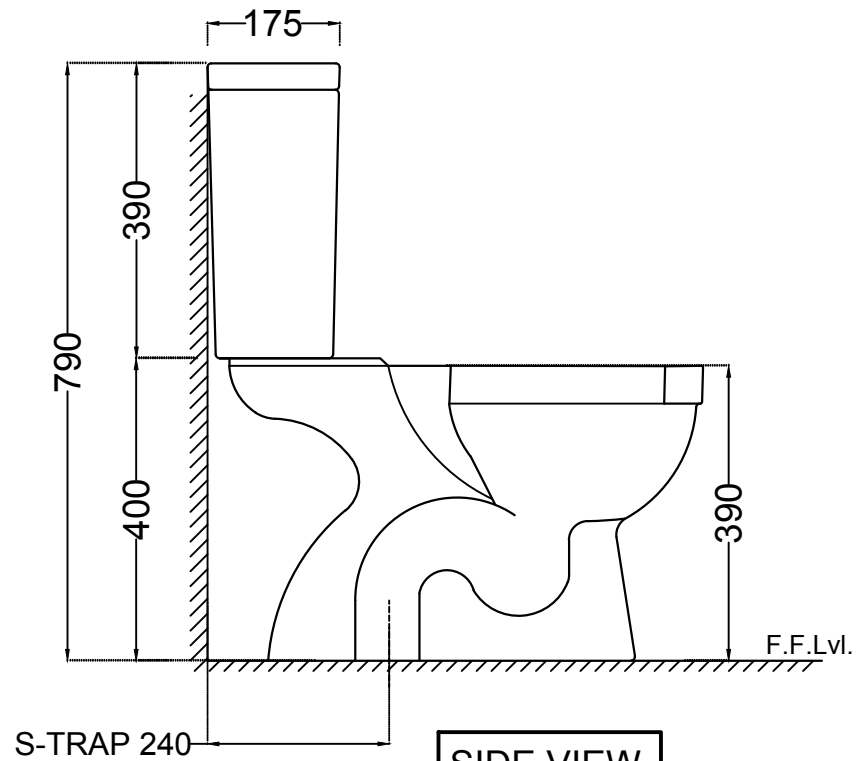

SIDE VIEW

	Jaquar Group	
	ITEM CODE	SLS-WHT-6751S240PPZ
	ITEM TYPE	COUPLED WC S-TRAP-240 MM
	ITEM SIZE	375x650x790mm
Global Headquarters Plot No. 3, Sector- M-11, IMT Manesar Gurgaon, NCR - 122050, India E-mail : Sales: support@jaquar.com Customer Service : service@jaquar.com		ALL DIMENSIONS ARE IN MM. (TOLERANCE ± 5 MM)